

ABACO CAPIRIATE

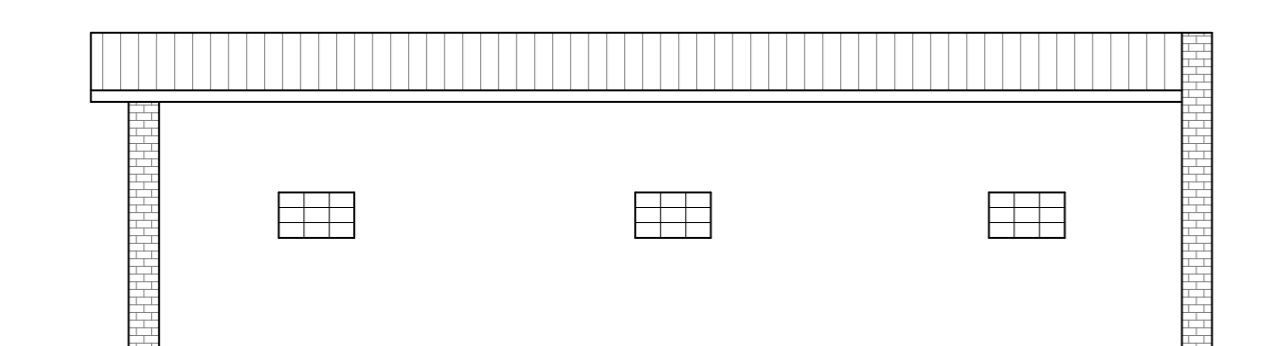

PROSPETTO SUD

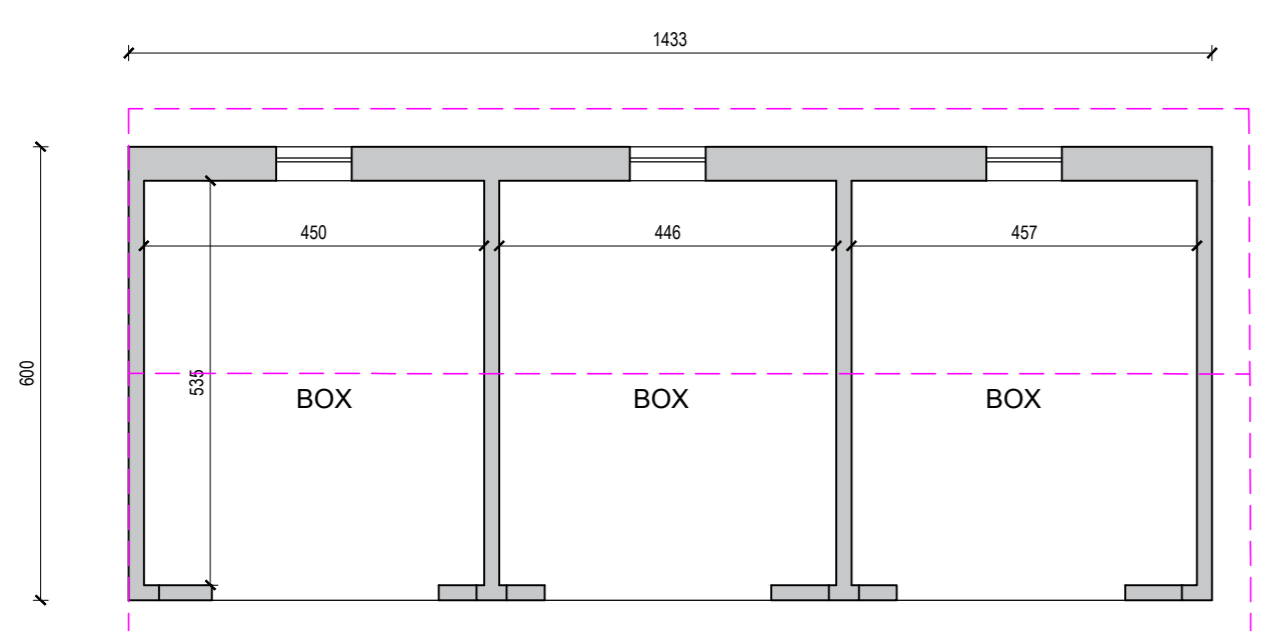

PIANTA EDIFICIO "BASSO"

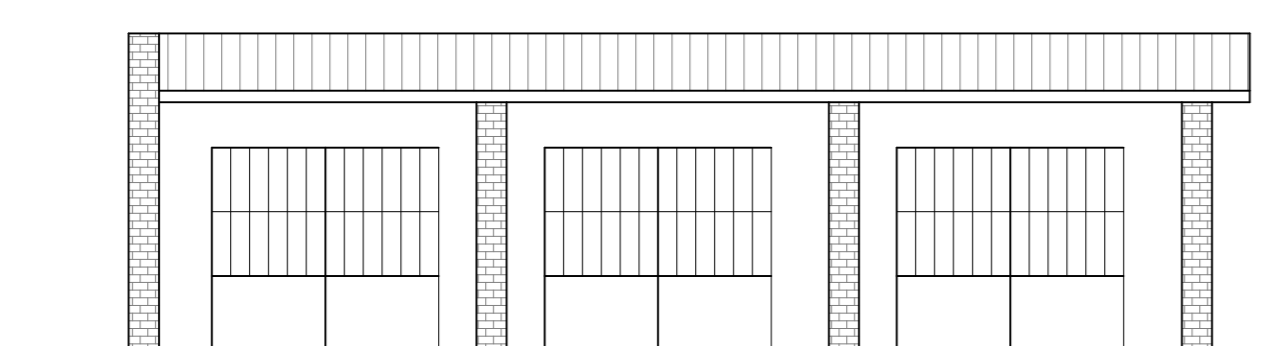

PROSPETTO NORD

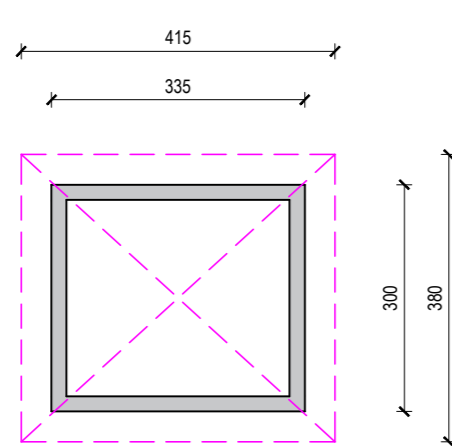

PIANTA CABINA ENEL



STUDIO DI PROGETTAZIONE
Foppiani Ing. Sergio

via Anguissola n. 7 Roveto di Cadore
PIACENZA cap. 29010 tel./fax 0523-507158
C.P. FPPSRG65B05D6111 P.IVA 01100320330



COMUNE	COMMITTENTE	TAVOLA
FARINI	COMUNE DI FARINI	2
PROGETTO RIFACIMENTO COPERTURE MAGAZZINI		
DESCRIZIONE STATO DI FATTO: PIANTE, SEZIONE E PROSPETTI		
SCALA	DATA	PRATICA
1:100	27/07/2017	17.078

Ci riserviamo la proprietà di questo disegno con divieto di riproduzione e di renderlo noto a terzi senza autorizzazione.

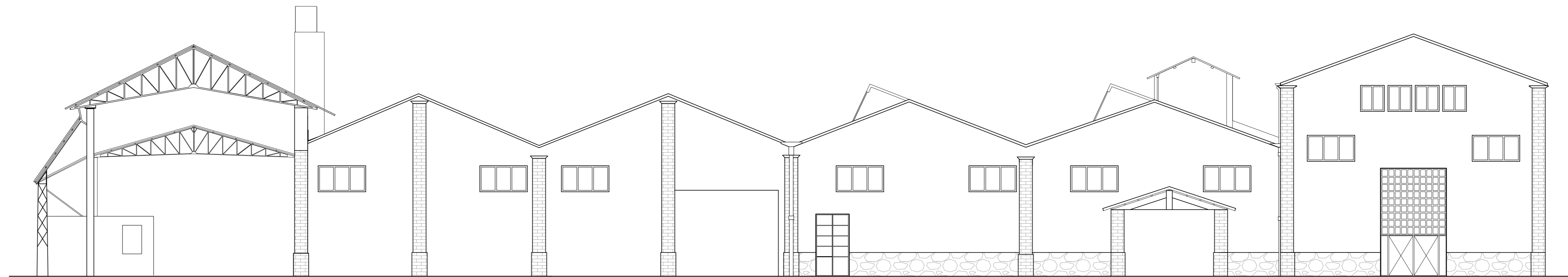

PROSPETTO NORD

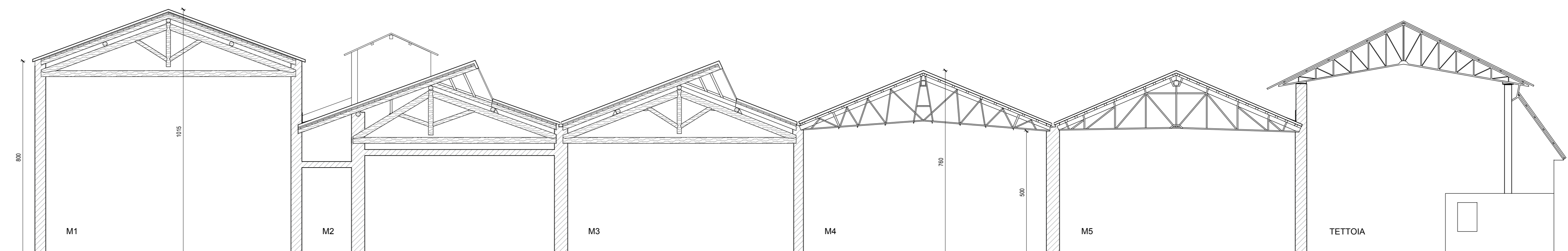

SEZIONE A-A

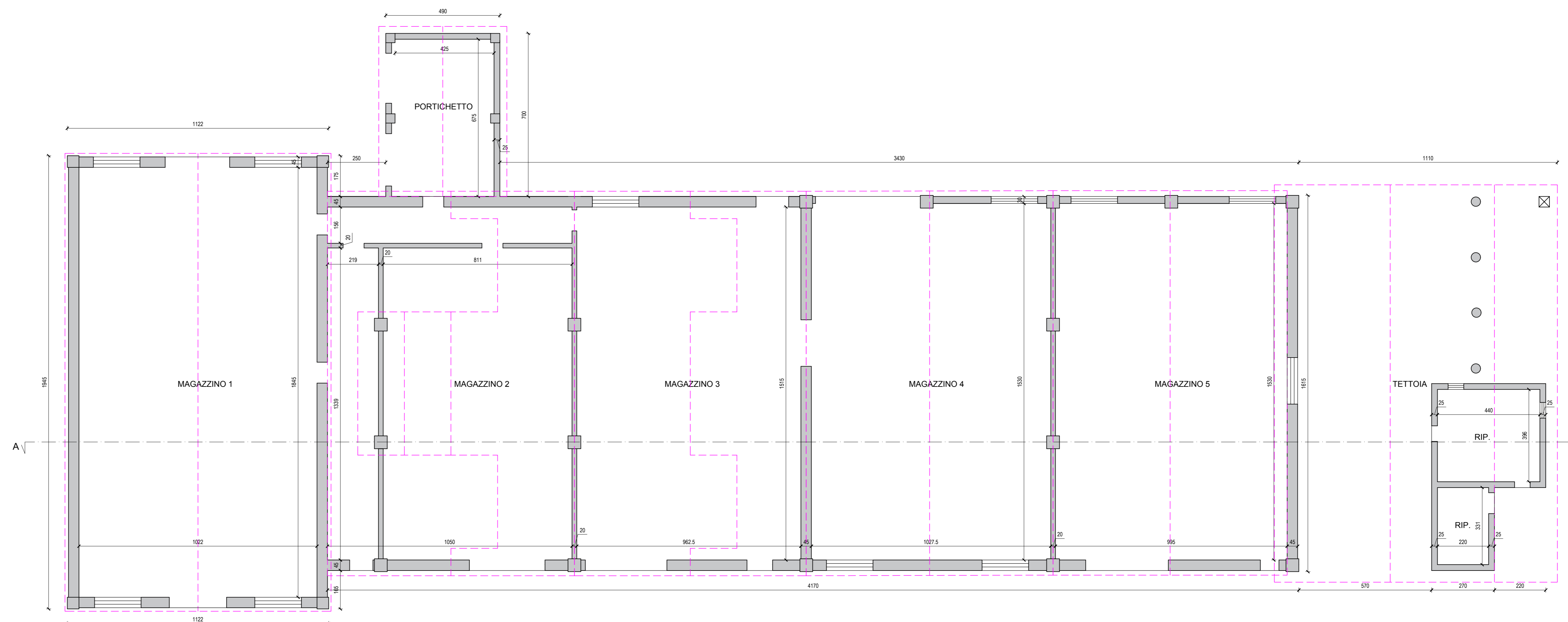

PIANTA MAGAZZINI E IMPRONTA COPERTURE



PROSPETTO SUD